



User / Installation Manual

Marine CD/MP3 Receiver

MS-CD80



Specifications and design are subject to change without notice.

Contents

| | |
|---------------------------|----|
| Installation | 1 |
| Button Description | 4 |
| General Operation | 5 |
| Menu Selection Function | 6 |
| Radio Operation | 6 |
| CD Operation | 7 |
| MP3/WMA Operation | 8 |
| iPod® Operation | 9 |
| USB Operation | 10 |
| Supported MP3/WMA Formats | 10 |
| Technical Specifications | 12 |
| Tuning Range | 12 |
| Notes | 13 |

RECORD YOUR PRODUCT DETAILS HERE:

MODEL NUMBER _____ DATE OF PURCHASE _____

AFFIX RECEIPT HERE

Installation

Headunit Installation

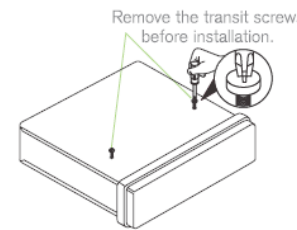

Before installing the unit, please remove the two transit screws.

Note: When installing this unit on a vessel, use the two pieces of plastic film (supplied with the unit) to seal the two holes after removing the screws.

Mounting Hole Dimensions 180mmW x 178mmD x 50mmH

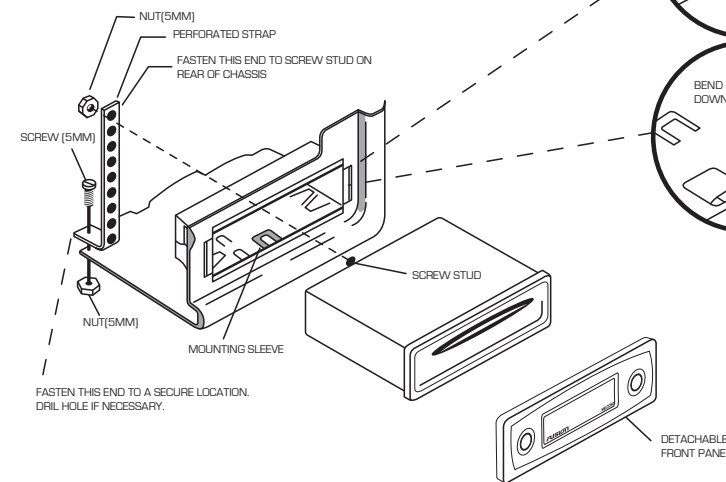
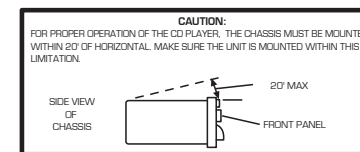

Insert the sleeve into the mounting hole and select the appropriate tabs to secure it firmly by bending them into position.

Use the supplied strap to support the rear of the unit.

Removing The Unit

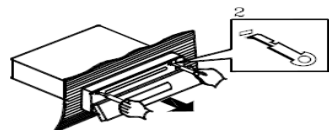
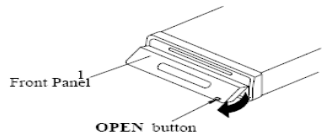

1. Press the open button the face plate
2. Insert the supplied keys into the grooves in the housing until they click (as shown)
3. Pull the levers towards you and slowly remove the unit from the cage.

Detaching Front Panel

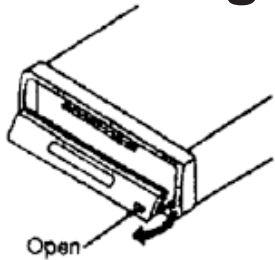

1. To detach the front panel press the open button
2. Then press the release button on the front underside edge and slide the face toward you.
3. A protective case is supplied to store your removeable front panel in.

Reattaching Front Panel

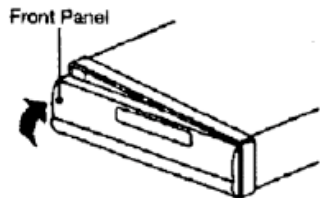

1. If the panel bracket is in the open position slide the panel back on into position.
2. If the panel bracket is in the upright position clip one end in firstly and then clip the other end in and the panel will lock in place.

Wiring Connections

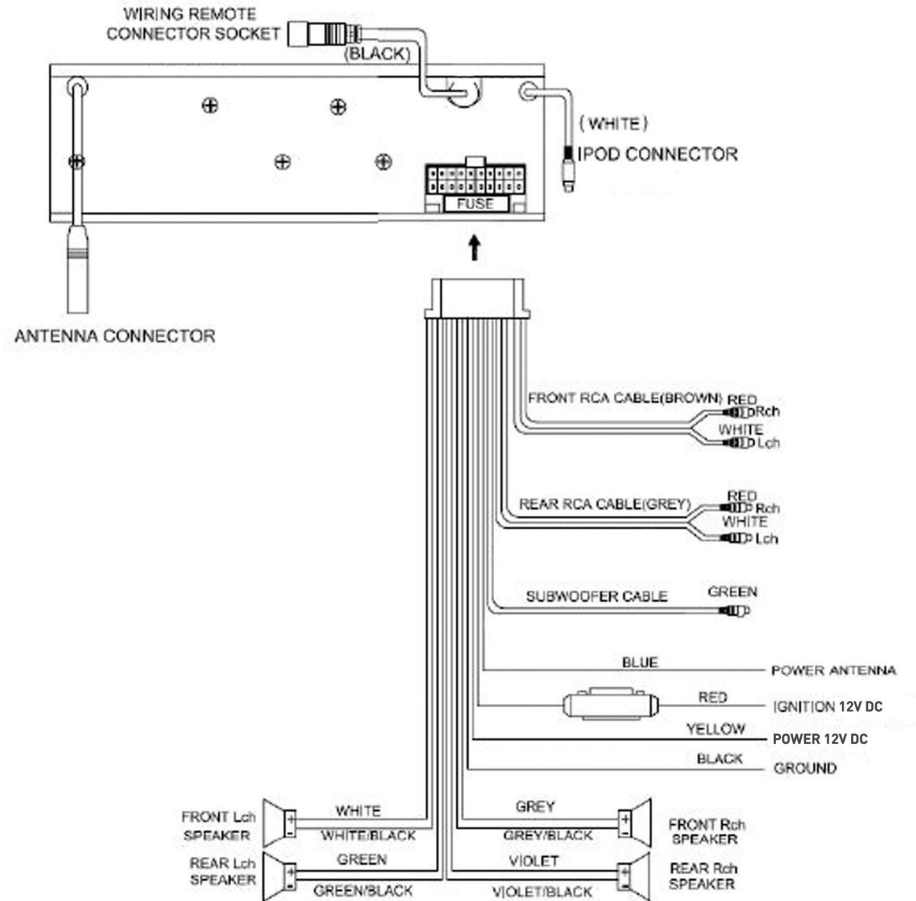

Button Description

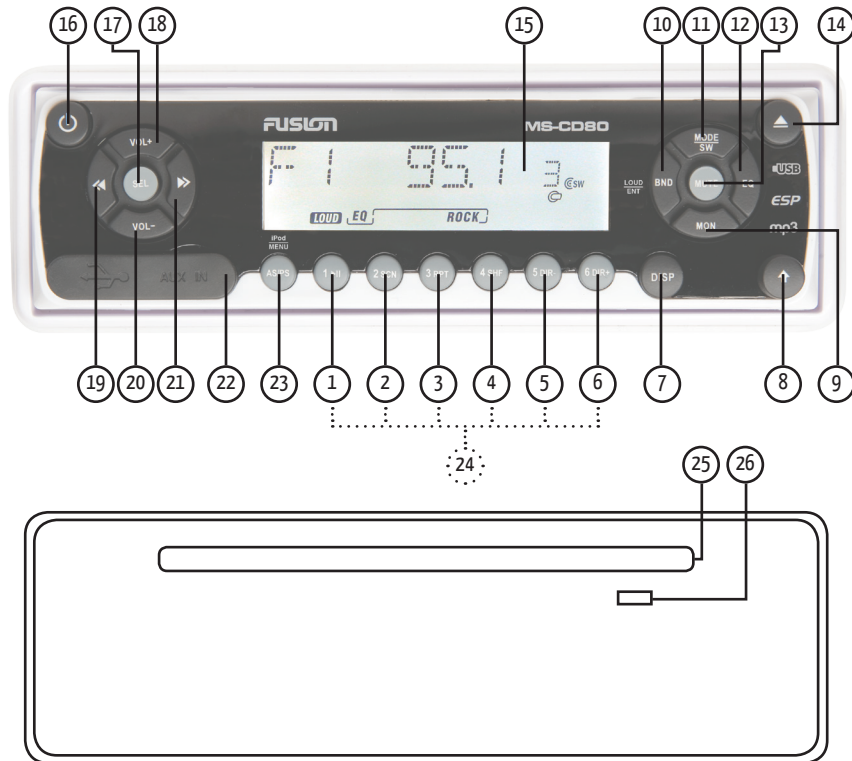

- | | |
|------------------------|------------------------------------|
| 1. ▶ Play/Pause | 15. LCD Screen |
| 2. SCN (track preview) | 16. Power ON/OFF |
| 3. RPT (Repeat) | 17. SEL/MENU |
| 4. SHF (Shuffle) | 18. Volume Up + |
| 5. DIR - | 19. ◀◀ Rewind |
| 6. DIR + | 20. Volume Down - |
| 7. DISPLAY | 21. ▶▶ Forward |
| 8. OPEN | 22. USB/AUX 3.5mm Socket Interface |
| 9. MON -Mono/Stereo | 23. AS/PS - Auto store preset scan |
| 10. BND/LOU/ENT | iPod Menu |
| 11. MODE/Sub Woofer | 24. Preset Station Buttons (1-6) |
| 12. EQ (Equaliser) | 25. Disc Slot |
| 13. Mute | 26. Reset button |
| 14. ▲ (Eject) | |

General Operation

POWER ON/OFF

Press the power ON/OFF button (16)

FRONT PANEL RELEASE

Press OPEN button (8) to open the front panel

SOUND ADJUSTMENT

Press the SEL/MENU button (17) repeatedly to cycle the audio mode through bass, treble, balance and fader modes. Press the VOLUME UP button or VOLUME DOWN button to adjust the selected mode.

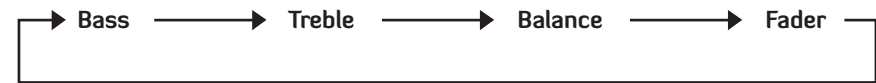

SETTING THE CLOCK

Press the DISPLAY button once to switch to display clock, then press and hold the DISPLAY Button until the clock is displayed and flashes. Press the button to change the minutes and the button to change the hours. Press DISPLAY button to confirm and exit.

MUTE

Press MUTE button to mute the sound. Press again to resume.

LOUDNESS

Press and hold the BND/LOU/ENT button (10) to reinforce the bass output. Press again to cancel.

MODE SELECTION

Press the MODE/SW button to cycle through the source modes. Only active modes will be displayed. Eg. If there is no CD loaded CD mode will not be selectable.

SUBWOOFER LINE OUT

Press and hold MODE/SW button (11) to activate the Subwoofer output. Repeat to deactivate

EQUALIZATION

Press the EQ button repeatedly to cycle through and select the EQ option you desire.

ESP

Electronic shock protection provides a 10 second read ahead buffer.

RESET BUTTON

The RESET button is located in the housing of the unit button (26) and must be activated with a ballpoint pen or something similar under the following conditions.

1. An error symbol is displayed
2. Function buttons do not operate correctly

Menu Selection Function

Press and hold SEL button (17) to enter Menu Select Mode. Press the VOLUME UP button (18) or the VOLUME DOWN button (20) to adjust the BEEP function.

BEEP 2nd MODE

Only beeps on press and hold functions.

BEEP ALL

Beeps on all key presses.

BEEP OFF

Beeps disabled.

Radio Operation

Press the MODE button (11) to select the Radio mode.

SELECTING FREQUENCY BAND

Press BND/LOU/ENT button (10) to cycle through and select the desired band



SELECTING STATION

Auto Seek

Press the ◀ button (19) or ▶ button (21) to activate the automatic seek function up or down the frequency spectrum.

Manual

Press and hold the ◀ button (19) or the ▶ button (21) until MANUAL appears on the screen. If neither button is pressed for several seconds the unit will switch to AUTO SEEK.

AUTOMATIC MEMORY STORING AND PRESET SCAN

Automatic Memory Storing

Press and hold the AS/PS button (23) and the unit will search for the strongest signals and then store them in the presets.

Preset Scan

Press the AS/PS button (23) to preview all stored preset stations. Stations with weak signal levels are bypassed.

STORING PRESET STATIONS

There are six presets available for each band (FM1, FM2, FM3 and AM).

1. Select the desired band and tune in the station you want to store.
2. Press and hold the PRESET button (24) 1-6 until a beep is heard to confirm and the preset number is displayed.

MONO/STEREO

Press MON button (9) to select Mono or Stereo mode.

TUNER REGION SETUP

To change the tuner region between Europe (EUR) and USA (default is Europe),

1. Press and hold SEL/MENU button (17) until region displayed.
2. Then press VOL + (18) or VOL - (20) buttons to cycle.

CD Operation

If there is no CD loaded press OPEN Button (8) and gently insert the disc until you feel some resistance. The CD will be drawn into the unit and playback will begin.

If there is a CD already in the unit press the MODE button (11) until CD mode is displayed.

EJECTING A DISC

Press the OPEN button (8) and press the EJECT button (14).

Press again to cancel.

PAUSE PLAY

Press PAUSE/PLAY button (1) to pause play, press again to resume.

SHUFFLE

Press the SHF button (4) to play the tracks in a random order. Press again to cancel.

TRACK SELECTION

Press the ◀ button (19) to skip to the previous track or ▶ button (21) to skip to the next track.

Press and hold ◀ (21) to FAST FORWARD and (19) to FAST REWIND. ▶▶

REPEAT TRACK

Press RPT button (3) to continuously repeat the track.

MP3/WMA Operation

TRACK SELECTION

Press the button (19) to skip to the previous track or button to skip to the next track.

DIRECTORY SELECTION

Press DIR - button (5) or DIR + button (6) to navigate the directory. If your tracks are arranged in albums this function steps up and down albums.

DIRECT TRACK SEARCH

Press the iPod Menu button (23) once to enter the search mode then select the track number as follows:

Method 1: VOLUME +/- button (18 & 20) and confirm by pressing the BND/LOU/ENT button (10).

Method 2: Direct numeric entry with the buttons 1-6 (1, 2, 3, 4, 5, 6), MODE/SW (7), TUNE (8, 9), DISP (0) button and confirm by pressing the BND button.

DIRECTORY OR FILE NAME SEARCH

Press the iPod Menu button (23) twice to enter the search mode.

Method 1: Characters are entered via the VOLUME +/- button (18 & 20). Characters available are A-Z, 0-9, _,-,+. Enter the desired character and confirm with the SEL/MENU button (17) the cursor will move to the next digit. Once complete press the BND/LOU/ENT button (10) to begin search.

Method 2: Direct numeric entry as shown in the following table:

SEARCHING ROOT DIRECTORY

| BUTTON | FUNCTION | BUTTON | FUNCTION |
|--------|-------------------------------|---------|-------------------------------------|
| AS/PS | Mode Select | BND/LOU | ENT |
| 1 | A, B, C, 1 | 2 | D, E, F, 2 |
| 3 | G, H, I, 3 | 4 | J, K, L, 4 |
| 5 | M, N, O, 5/ Directory DOWN | 6 | P, Q, R, 6/ Director UP |
| MOD | S, T, U, 7 | | V, W, X, 8 |
| | Y, Z, SPACE, 9 | SEL | Character Shift Right |
| DISP | _,-, +, 0 | VOL + | Character Select (A-Z, 0-9, +,-) |

Press the iPod Menu button (23) three times to enter the search mode. Press the (19) and (21) buttons to select the directory or file name displayed the press BND/LOU/ENT to play the selection.

SEARCHING CURRENT DIRECTORY

Press the iPod Menu button (23) four times to enter the search mode. Press the (19) and (21) buttons to select the directory or file name displayed the press BND/LOU/ENT to play the selection.

PAUSE PLAY

Press PLAY/PAUSE button (1) to pause MP3 play. Press to resume.

REPEAT SONG OR FOLDER

Press RPT button (3) to continuously repeat the current song. Press and hold RPT to repeat all songs in the current folder. Press again to cancel.

SHUFFLE

Press SHF button (4) to play all songs in random. Press and hold to select a folder and play contents of folder in random order. Press again to cancel.

PREVIEW ALL SONGS

Press SCN button (2) to play the first several seconds of each song. Press and hold to play the first several seconds of the first track in each folder. Press again during intro to play entire track.

DISPLAY INFORMATION

Press DISP button (7) to display the Clock, ID3 Tag (if available: Directory name, Song title, Artist name).

WMA OPERATION

Operation of discs recorded in this format is the same as MP3.

iPod® Operation

There are three options to connect an iPod to the unit:

Option 1: Via the MS-IP15L accessory cable (available separately).

Option 2: Via the MS-IPDOCK Marine External Dock (available separately). For a full list compatible iPods see the MS-IPDOCK manual product manual or visit www.fusionelectronics.com

Option 3: Via the auxiliary input 3.5mm front panel input.

IPOD MENU SEARCH

During playback press iPod Menu button (23) to display menu. Press the Volume Down button (20) or Volume Up (18) button to navigate the menu and search by the following categories.

PLAYLIST/ARTIST/ALBUM/GENRE/SONG/COMPOSER

Press SEL/MENU button (17) to enter the selected sub menu and search within the folder in the same manner pressing Volume Down/Up buttons (20, 18) and SEL/MENU (17).

DISPLAY

During playback press DISP button (7) to display current song information
SONG TITLE/ARTIST/ALBUM NAME/CLOCK/TRACK/PLAY TIME.

PAUSE PLAY

Press PAUSE/PLAY button (1) to pause play, press again to resume.

REPEAT TRACK

During playback press RPT button (3) and RPT will be displayed press again to cancel.

RANDOM PLAY

During playback press SHF button (4) once the current selection has finished playing, all songs in the current category will play in a random order. Press again to cancel.

TRACK SELECTION

During playback press button (21) to select the next track. Press button (19) to play the previous track. If the song has been played more than 1 second it will resume play from the beginning, if playing more than 2 seconds the previous song will be selected.

FAST FORWARD

Press and hold button (21) for 2 seconds to activate.

REWIND

Press and hold button (19) for 2 seconds to activate.

AUXILIARY INPUT

Connect an Auxiliary device to the front 3.5mm AUX socket. Press MODE button (11) to select AUX.

USB Operation

Connect the USB device via the USB interface (22) and playback of MP3/WMA files will start automatically. USB mode can be selected with the MODE button (11). Operation of the USB is identical to MP3 operation. (see page 8)

CAUTION: To safely eject the USB device ensure you change the mode to another source before removing the device.

NOTE: This product does not support all USB/MP3 players.

WARNING: Ensure when connecting an MP3 player via the USB interface that it has rechargeable batteries NOT standard batteries in use as this may cause the batteries to explode.

Supported MP3/WMA Formats

NOTES ON MP3 FILES

1. The disc must be in the ISO9660 level 1 or level 2 format.
2. When naming a MP3 file, be sure the file name extension is "MP3".
3. For a non-MP3 file, even though the file name extension is "MP3", the unit cannot recognise it.

1) MP3: Compliant with layer 3 of MPEG1

- Sampling rates (kHz): 44.1
- Bit rates (kbps): 16, 24, 32, 40, 48, 56, 64, 80, 96, 112, 128, 144, 160, 192, 224, 256, 320 variable bit rates supported.

2) WMA: Compliant with Windows Media Audio 9

- Sampling rates (kHz): 44.1
- Bit rates (kbps): 32 to 192 does not support DRM and Lossless, Professional and Voice of WMA9

| | MP3/WMA |
|--------------|---------|
| Max Files | 999 |
| Max Folders | 500 |
| Folder Depth | 8 |

HANDLING COMPACT DISCS (CD/CD-R/CD-RW)

- Avoid touching the surface
- Avoid exposing the disc to direct sunlight
- Ensure the disc is clean
- Ensure the disc is not scratched or damaged.

PLAYBACK OF CD-R/CD-RW

- If your CR-R/CD-RW will not play. Ensure that the last recording session was closed or finalised.

SUPPORTED MEDIA

- Only use compact discs with the CD logo's on the label as listed below.



- If you use compact discs without the above logo's, correct performance cannot be guaranteed
- You can play audio discs recorded on CD-R (Recordable) and CD-RW (Re Writable) media

Windows Media and the Windows logo are trademarks, or registered trademarks of Microsoft Corporation in the United States and/or other countries. Apple, the Apple logo, iPod and iTunes are Trademarks of Apple Computer, Inc, registered in the U.S. and other countries.

"MPEG Layer-3 audio coding technology licensed from Fraunhofer IIS and Thompson."

"Supply of this product only conveys a licence for private, non-commercial use and does not convey a licence nor imply any right to use this product in any commercial (i.e. revenue generation) real time broadcasting (terrestrial, satellite, cable and/or any other media), broadcasting/streaming via internet, intranets and/or other networks or in other electronic content distribution systems, such as pay-audio or audio-on-demand applications. An independent license for such use is required. For details, please visit <http://www.mp3licensing.com>"

